

# WALL CABINET ASSEMBLY INSTRUCTION

W(24-42)36

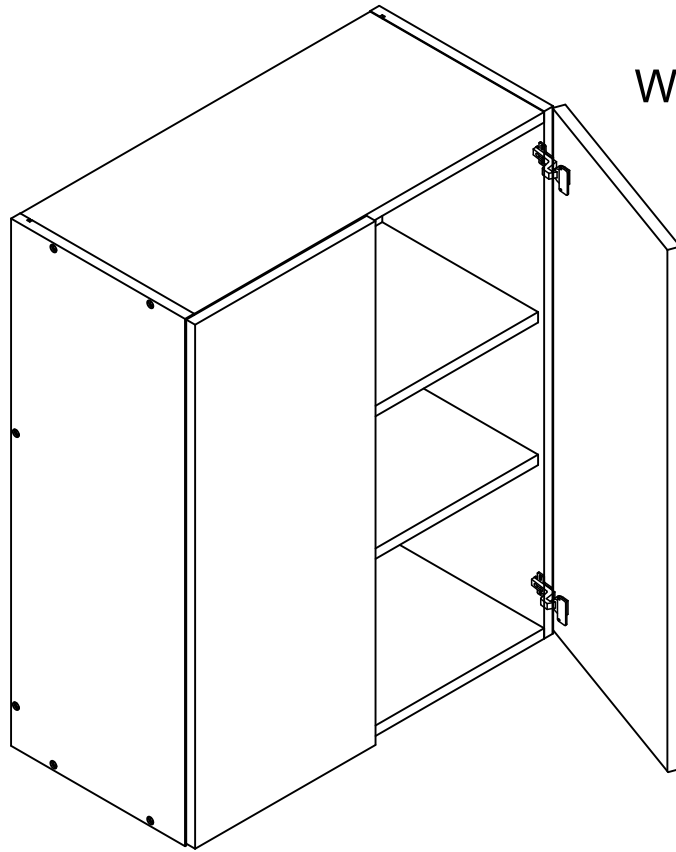





## Assembly instructions

**Carefully read the Instructions before starting the installation.**

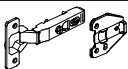
**During assembly, please follow all generally accepted safety procedures.**

**If you are missing any part, please stop and contact us immediately at**

Hardware Fitting		
Hinge		4PCS
Shelf Support		8PCS
Screws for hinge	 4*16	24PCS
Bumper		4PCS
Cabinet Screws	 7*50	14PCS

Left Side Panel	1PC
Right Side Panel	1PC
Bottom Panel	1PC
Back Panel	1PC
Support Rail	3set
Top Panel	1PC
Removable Shelf	2PC

Step1

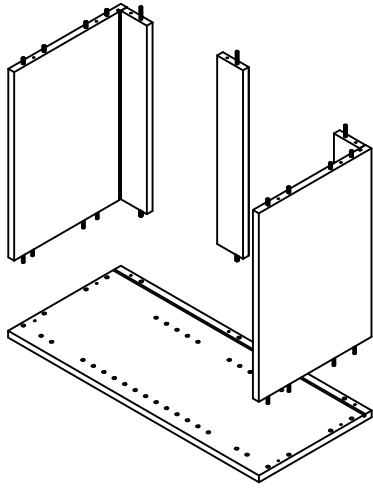

Step2

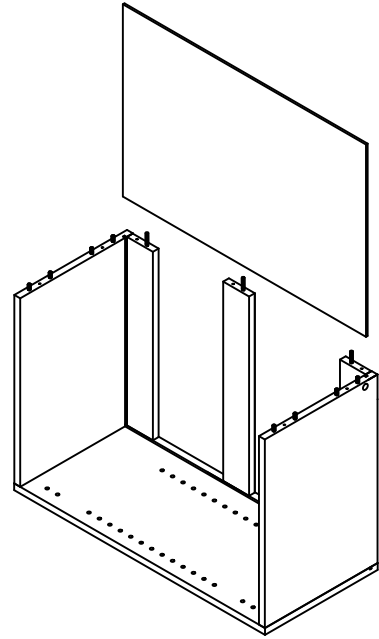

Step3

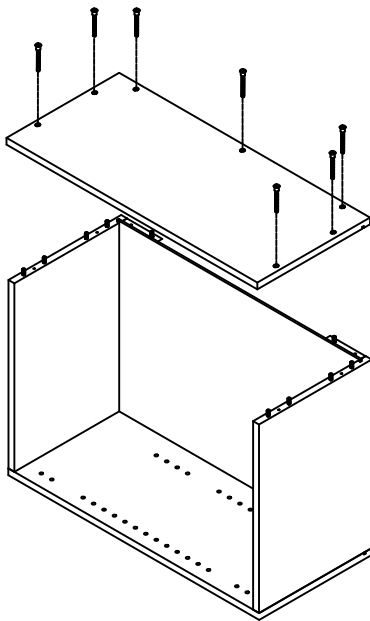

Step4

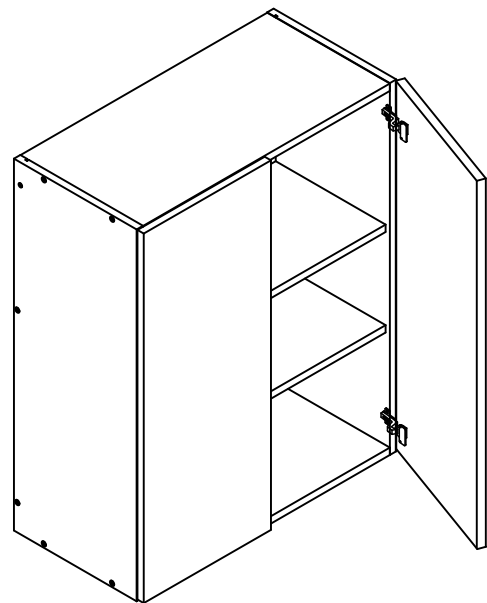

The other side plate is also assembled in this way